

Power Relays

G7Z

High-capacity Power Relays Capable
of Carrying and Switching 40 A at 440 VAC

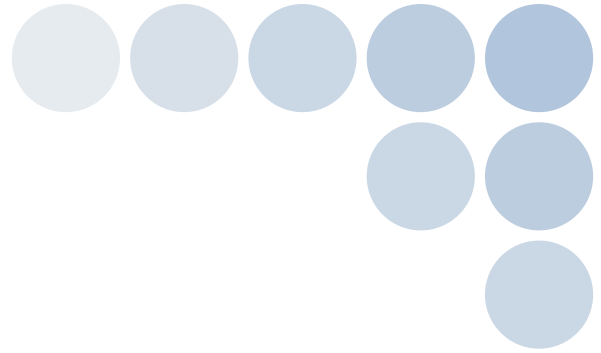

Compact
40%
smaller than
contactors (IEC-
AC1, 50-A
specifications)

High Capacity
IEC-AC1 40-A rating
4-pole power fully applied:
160 A

Mirror Contacts
for
Safety Function

High Insulation
Load switching for
400-VAC systems

**RoHS
Compliant**

**Simple
Mounting**

Low Noise
Approx. 70 dB

**Low Power
Consumption**
Less than 4 W DC



High-capacity Power Relays for Use in Contactor Current Ranges

G7Z

Customers want to use contactors with greater ease for AC 1 class (IEC load) switching, and the G7Z Power Relays were developed to meet those needs. As the No.1 leader in production performance in Relays, OMRON has implemented crossover technologies for the new design of the G7Z.

Along with providing switching in the conventional contactor range of 40 A with the size and convenience of a conventional relay, we have also achieved an ecological relay-the user-friendly, high-capacity G7Z.

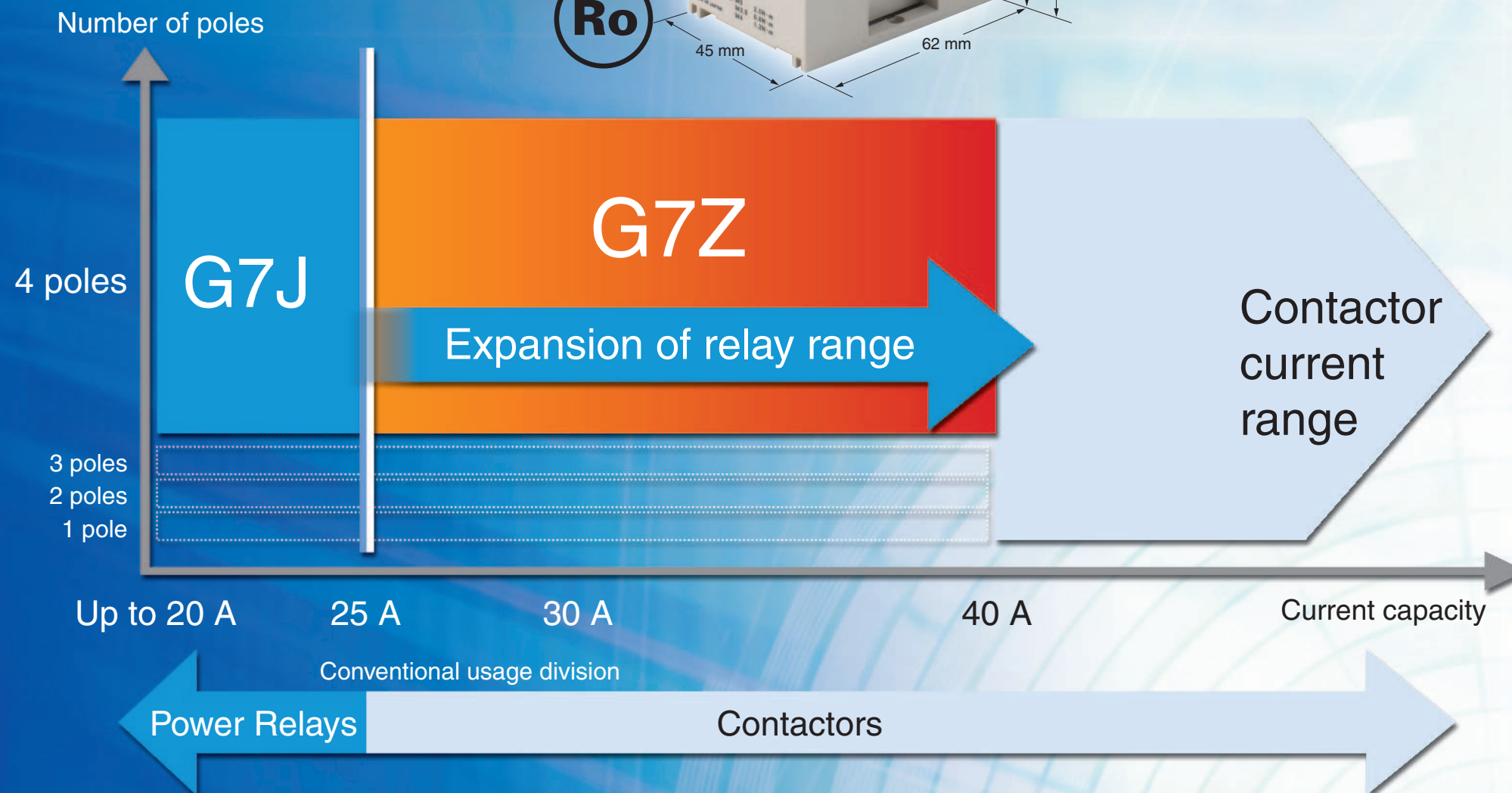

High Capacity and High Insulation

Continuously apply 40 A at 440 VAC, or apply up to a maximum of 160 A by using 4-pole parallel connections for full power application.* The Relays are highly insulated to support load switching of 40 A at 440 VAC

* Always consult with your OMRON representative before using the maximum current of 160 A.

Compact Size

Downsizing of approximately 40% volume compared with contactors.* Contributes to space savings in control panels.

* IEC-AC1 50-A specifications

Safety Function with Mirror Contacts

EN 60947-4-1 certification for mirror contact mechanisms has been obtained by using a combination of a relay and auxiliary contact blocks (5 VDC, 1 mA), enabling application in feedback circuits of safety circuits.

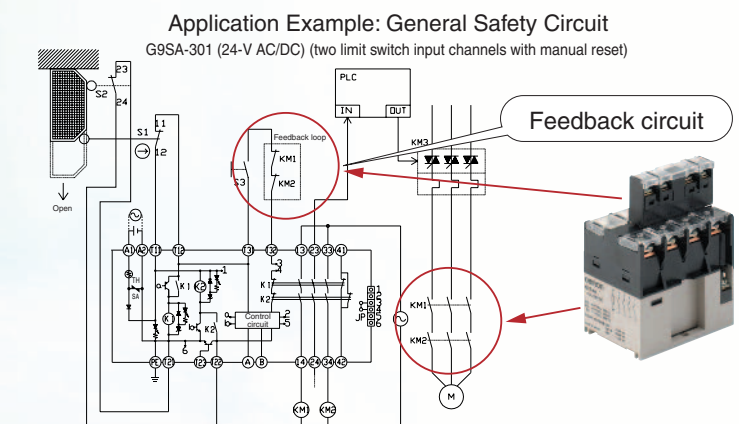

Low Noise and Low Power Consumption

Low noise of approx. 70 dB compared with the approx. 100 dB for contactors.* Low power consumption of less than 4 W DC. Environmentally friendly specifications.

* IEC-AC1 50-A specifications

DIN Track Mountable

The Relay can be easily mounted right on a DIN Track.



Power Relays G7Z

Multi-pole Power Relay for Contactor Current Range Capable of Carrying and Switching 40 A at 440 VAC

- One pole, 40 A can be carried and switched.
- The maximum load capacity of 160 A when using 4-pole parallel connections.
- All materials used are compliant with the RoHS Directive
- EN 60947-4-1 certification for mirror contact mechanisms has been obtained by using a combination of the relay and auxiliary contact blocks.

Note: Refer to the *Precautions for Correct Use* on page 9.

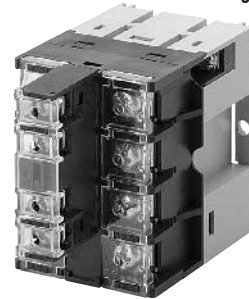

NEW

Model Number Structure

Model Number Legend

Relay with Auxiliary Contact Block

G7Z-□-□□
1 2 3

1. Relay Contact Configuration

- 4A: 4PST-NO
- 3A1B: 3PST-NO/SPST-NC
- 2A2B: DPST-NO/DPST-NC

2. Contact Configuration of Auxiliary Contacts

- 20: DPST-NO
- 11: SPST-NO/SPST-NC
- 02: DPST-NC

3. Contact Mechanism of Auxiliary Contacts

- Z: Bifurcated crossbar contact

Auxiliary Contact Block

G73Z-□□
1 2

1. Contact Configuration of Auxiliary Contacts

- 20: DPST-NO
- 11: SPST-NO/SPST-NC
- 02: DPST-NC

2. Contact Mechanism of Auxiliary Contacts

- Z: Bifurcated crossbar contact

Configuration

Classification	Structure	Contact configuration		Screw terminals 	
		Relay	Auxiliary Contact Block		
Relay with Auxiliary Contact Block	4 poles + 2 poles	4PST-NO	DPST-NO	G7Z-4A-20Z	
			SPST-NO/SPST-NC	G7Z-4A-11Z	
			DPST-NC	G7Z-4A-02Z	
		3PST-NO/SPST-NC	DPST-NO	DPST-NO	G7Z-3A1B-20Z
				SPST-NO/SPST-NC	G7Z-3A1B-11Z
				DPST-NC	G7Z-3A1B-02Z
		DPST-NO/DPST-NC	DPST-NO	DPST-NO	G7Z-2A2B-20Z
				SPST-NO/SPST-NC	G7Z-2A2B-11Z
				DPST-NC	G7Z-2A2B-02Z
Auxiliary Contact Block	2 poles	---	DPST-NO	G73Z-20Z	
			SPST-NO/SPST-NC	G73Z-11Z	
			DPST-NC	G73Z-02Z	

Note: 1. Relay contact terminals are M5, and the coil terminals are M3.5.

2. Auxiliary contact block terminals are M3.5.

Ordering Information

■ Relay with Auxiliary Contact Block

Relay with Auxiliary Contact Block (for Screw Terminals)

Contact configuration		Rated voltage	Model
Relay	Auxiliary contact block		
4PST-NO	DPST-NO	12, 24 VDC	G7Z-4A-20Z
	SPST-NO/SPST-NC	12, 24 VDC	G7Z-4A-11Z
	DPST-NC	12, 24 VDC	G7Z-4A-02Z
3PST-NO/SPST-NC	DPST-NO	12, 24 VDC	G7Z-3A1B-20Z
	SPST-NO/SPST-NC	12, 24 VDC	G7Z-3A1B-11Z
	DPST-NC	12, 24 VDC	G7Z-3A1B-02Z
DPST-NO/DPST-NC	DPST-NO	12, 24 VDC	G7Z-2A2B-20Z
	SPST-NO/SPST-NC	12, 24 VDC	G7Z-2A2B-11Z
	DPST-NC	12, 24 VDC	G7Z-2A2B-02Z

■ Accessories (Order Separately)

Auxiliary Contact Block

Contact configuration	Model
DPST-NO	G73Z-20Z
SPST-NO/SPST-NC	G73Z-11Z
DPST-NC	G73Z-02Z

Specifications

■ Ratings

Coil Ratings

Item	Rated current	Coil resistance	Must operate voltage	Must release voltage	Maximum voltage	Power consumption
Rated voltage	Percentage of rated voltage					
12 VDC	333 mA	39 Ω	75% max.	10% min.	110%	Approx. 3.7 W
24 VDC	154 mA	156 Ω				

- Note:**
- Rated current and coil resistance were measured at a coil temperature of 23°C with coil resistance of ±15%.
 - Operating characteristics were measured at a coil temperature of 23°C.
 - The maximum allowable voltage is the maximum value of the fluctuation range for the Relay coil operating power supply and was measured at an ambient temperature of 23°C. There is, however, no continuous allowance.

Contact Ratings

Relay

Item	Model	G7Z-4A-□Z, G7Z-3A1B-□Z, G7Z-2A2B-□Z		
		Resistive load	Inductive load cosφ = 0.3	Resistive load L/R = 1 ms
Rated load	NO	40 A at 440 VAC	22 A at 440 VAC	5 A at 110 VDC
	NC	25 A at 440 VAC	10 A at 440 VAC	5 A at 110 VDC
Rated carry current	NO	40 A	22 A	5 A
	NC	25 A	10 A	5 A
Maximum contact voltage		480 VAC		125 VDC
Maximum contact current	NO	40 A		
	NC	25 A		
Maximum switching capacity	NO	17,600 VA	9,680 VA	550 W
	NC	11,000 VA	4,400 VA	550 W
Failure rate P value (reference value)		2 A at 24 VDC		

Auxiliary Contact Block

Item	Model	G73Z-20Z, G73Z-11Z, G73Z-02Z		
		Resistive load	Inductive load cosφ = 0.3	Resistive load L/R = 1 ms
Contact structure		Double break		
Contact material		Au clad + Ag		
Rated load		1 A at 440 VAC	0.5 A at 440 VAC	5 A at 110 VDC
Rated carry current		1 A		
Maximum contact voltage		480 VAC		125 VDC
Maximum contact current		1 A		
Maximum switching capacity		440 VA	220 VA	110 W
Failure rate P value (reference value)		1 mA at 5 VDC		

Note: The ratings for the auxiliary contact block mounted on the G7Z are the same as those for the G73Z auxiliary contact block.

■ Characteristics

Item	Classification Model	Relay (See note 6.)		Auxiliary contact block
		G7Z-4A-□Z, G7Z-3A1B-□Z, G7Z-2A2B-□Z		G73Z-20Z, G73Z-11Z, G73Z-02Z
Contact resistance (See note 2.)		100 mΩ max.		
Operating time (See note 3.)		50 ms max.		
Release time (See note 3.)		50 ms max.		
Maximum operating frequency	Mechanical	1,800 operations/h		
	Rated load	1,200 operations/h		
Insulation resistance (See note 4.)		1,000 MΩ min.		
Dielectric strength	Between coil and contacts	4,000 VAC, 50/60 Hz for 1 min		---
	Between contacts of different polarity	4,000 VAC, 50/60 Hz for 1 min		
	Between contacts of the same polarity	2,000 VAC, 50/60 Hz for 1 min		
Impulse withstand voltage	Between coil and contacts	10 kV, 1.2 × 50 μs		---
	Between contacts of different polarity	10 kV, 1.2 × 50 μs		
	Between contacts of the same polarity	4.5 kV, 1.2 × 50 μs		
Vibration resistance	Destruction	10 to 55 to 10 Hz, 0.5-mm single amplitude (1.0-mm double amplitude)		
	Malfunction	NO: 10 to 55 to 10 Hz, 0.5-mm single amplitude (1.0-mm double amplitude) NC: 10 to 32 to 10 Hz, 0.5-mm single amplitude (1.0-mm double amplitude)		
Shock resistance	Destruction	Screw mounting: 800 m/s ² , DIN Track mounting: 500 m/s ²		
	Malfunction	NO: 100 m/s ² NO: 25 m/s ²		
Endurance	Mechanical	1,000,000 operations min. (at 1,800 operations/h, contact no load)		
	Electrical (See note 5.)	AC resistive load: 80,000 operations AC inductive load: 80,000 operations DC resistive load: 100,000 operations (at 1,200 operations/h, rated load)		
Failure rate P value (reference value)		2 A at 24 VDC	1 mA at 5 VDC	
Ambient operating temperature		-25 to 60°C (with no icing or condensation)		
Ambient operating humidity		5% to 85%		
Weight		Approx. 330 g		

- Note: 1. The above values are initial values.
 2. The contact resistance for the Relay (G7Z) was measured with 1 A at 5 VDC using the voltage drop method.
 The contact resistance for the auxiliary contact block (G73Z) was measured with 0.1 A at 5 VDC using the voltage drop method.
 3. The operate time was measured with the rated voltage imposed with any contact bounce ignored at the ambient temperature of 23°C.
 4. The insulation resistance was measured with a 1,000-VDC megohmmeter applied to the same places as those used for checking the dielectric strength.
 5. The electrical endurance was measured at an ambient temperature of 23°C.
 6. The specifications for the auxiliary contact block mounted on the G7Z are the same as those for the G73Z auxiliary contact block.

■ Approved Standards

UL Standard: UL508, UL840 (File No. E41643)

Model	Coil ratings	Contact ratings		Number of test operations
G7Z	12, 24 VDC	NO contact	40 A, 480 VAC, 60 Hz (Resistive)	80,000
			5 A, 120 VDC (Resistive)	100,000
			22 A, 480 VAC, 60 Hz (General Use)	100,000
			D300* (1-A current applied)	---
		NC contact	25 A, 480 VAC, 60 Hz (Resistive)	100,000
			5 A, 120 VDC (Resistive) 10 A, 480 VAC, 60 Hz (General Use) D300* (1-A current applied)	---

Note: Auxiliary contact ratings

Model	Contact ratings	
G73Z	NO contact	D300 (1-A current applied)
	NC contact	

CSA Standard: CSA Certification by

CSA C22.2 No. 14

EN Standard/TÜV Certification: EN 60947-4-1 (Certification No. R50079155)

Model	Coil ratings	Contact ratings	
G7Z	12, 24 VDC	NO contact	AC-1: 40 A, 440 V, 50/60 Hz AC-3: 16 A, 440 V, 50/60 Hz DC-1: 5 A, 110 V *AC15: 0.5 A, 440 V, 50/60 Hz *DC13: 0.5 A, 110 V
		NC contact	AC-1: 25 A, 440 V, 50/60 Hz DC-1: 5 A, 110 V *AC15: 0.5 A, 440 V, 50/60 Hz *DC13: 0.5 A, 110 V
G73Z	---	NO contact	AC15: 0.5 A, 440 V, 50/60 Hz DC13: 0.5 A, 110 V
		NC contact	

Note: Auxiliary contact ratings

Reference Information

- UL 508: Industrial control devices
 UL 840: Insulation coordination including clearance and creepage distance for electrical devices
 CSA C22.2 No. 14: Industrial control devices
 EN 60947-4-1: Contactors

Connections

Terminal Arrangement/Internal Connections

Relay with Auxiliary Contact Block

G7Z-4A-20Z

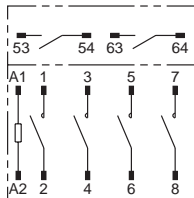

Note: The coil has no polarity.

G7Z-4A-11Z

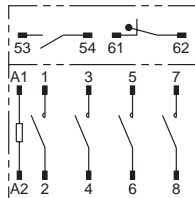

Note: The coil has no polarity.

G7Z-4A-02Z

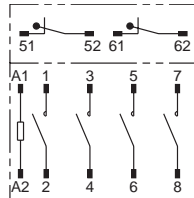

Note: The coil has no polarity.

G7Z-3A1B-20Z

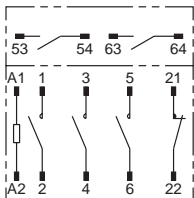

Note: The coil has no polarity.

G7Z-3A1B-11Z

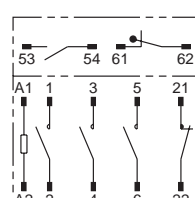

Note: The coil has no polarity.

G7Z-3A1B-02Z

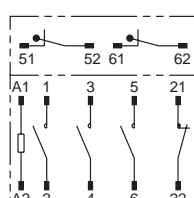

Note: The coil has no polarity.

G7Z-2A2B-20Z

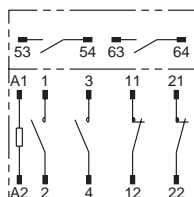

Note: The coil has no polarity.

G7Z-2A2B-11Z

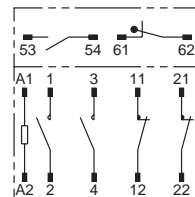

Note: The coil has no polarity.

G7Z-2A2B-02Z

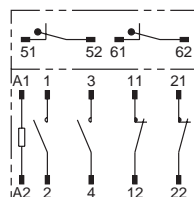

Note: The coil has no polarity.

Auxiliary Contact Block

G73Z-20Z

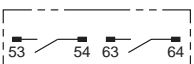

G73Z-11Z

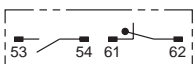

G73Z-02Z

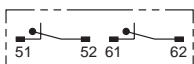

Dimensions

Note: All units are in millimeters unless otherwise indicated.

Relay (12 VDC, 24 VDC) with Auxiliary Contact Block

4 Poles

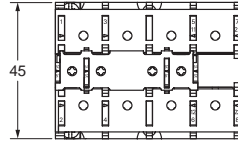
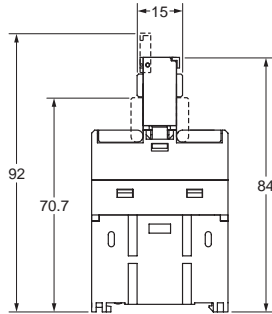

Mounting Hole Dimensions

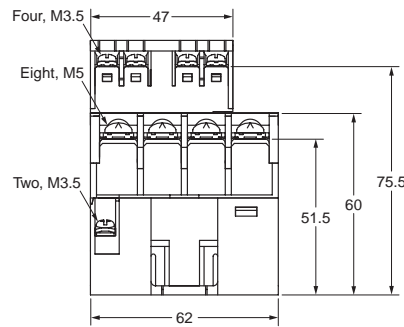
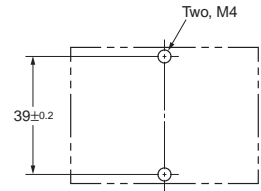

Note: The dimensions are typical values.

Auxiliary Contact Block

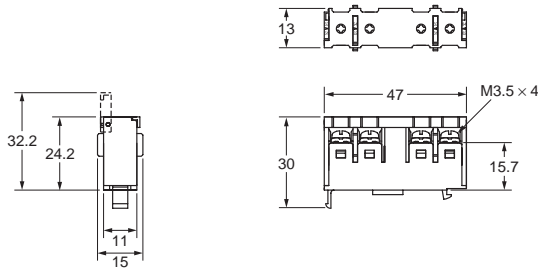

Note: The dimensions are typical values.

DIN Track Mounting Height

(when using the PFP-100N or PFP-50N mounting rail)

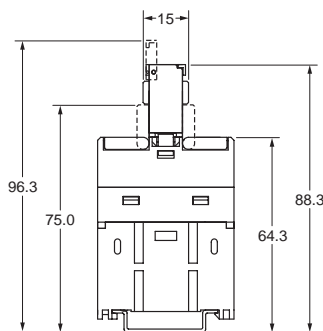

Note: The dimensions are typical values.

Application Examples

- Power supplies applied to Inverters and servo drivers for public and industrial use
- Power supplies applied to uninterruptible power supplies plus single- and three-phase power-supply switching for public and industrial use
- Single- and three-phase power-supply switching of photovoltaic power generation for public and industrial use
- Single- and three-phase power-supply switching of fuel cells for public and industrial use
- Switching of heaters and motor for industrial use

Precautions

Be sure to read the common precautions provided in *Best Control Devices Catalog Version 17* before using the Relay.

⚠ WARNING

Take measures to prevent contact with charged parts when using the Relay for high voltages.



⚠ CAUTION

Do not touch the terminal section (charged parts) when power is being supplied. Always use the Relay with terminal covers mounted. Contact with charged parts may result in electric shock.



Do not touch the Relay when power is being supplied or right after the power has been turned OFF. The hot surface may cause burn injury.



■ Precautions for Correct Use

Installation

- Mount the G7Z with the coil terminal at the top.

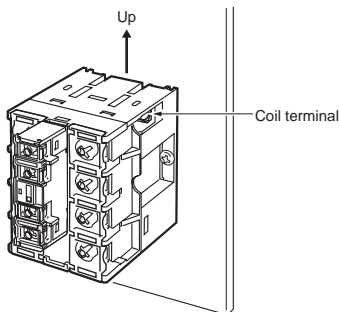

- Do not use the Relay with the terminal screw surfaces facing down.

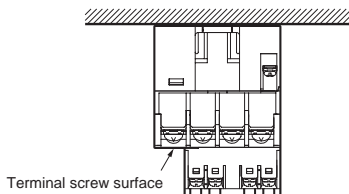

- To mount the Relay, secure M4 screws in two locations. Use a screw-tightening torque of 1.2 to 1.3 N·m.

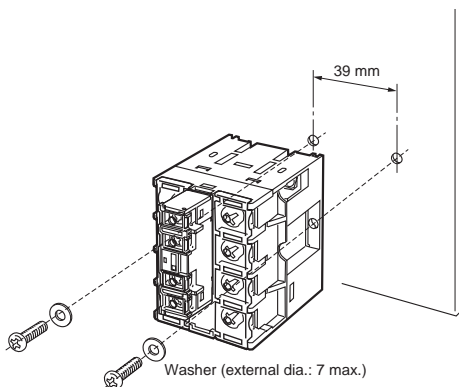

- The Relay can be mounted directly on a mounting rail (PTP) or a DIN Track (EN 50022-35 × 7.5, 15). The Relay cannot be mounted, however, to some reinforced rails (e.g., those produced by Kameda Denki or Toyogiken).
- Mount the Relay sideways when it is mounted on a rail.

- Use End Plates (PFP-M) on both sides of the Relay to make sure that it is properly secured.

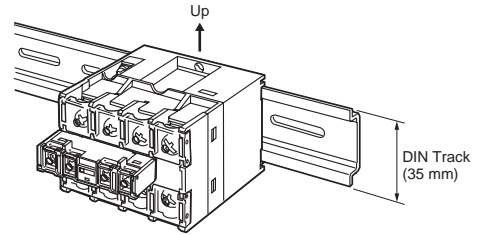

- Provide at least 5 mm of space between the sides and top of the Relay and nearby grounded metal surfaces.

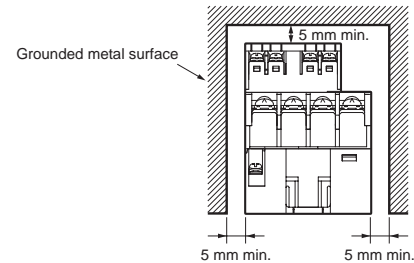

- Provide at least 30 mm of space between Relays when two or more Relays are mounted in a row.

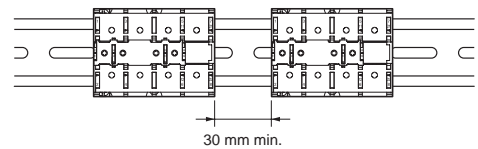

- The auxiliary contact block (G73Z) can be mounted on the Relay.

Mounting and Removal

Mounting

Insert the tab on the auxiliary contact block into the groove on the Relay and press down until the hook on the auxiliary contact block catches in the mounting hole on the Relay.

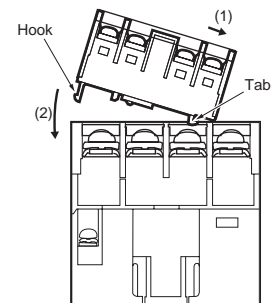

Removing

Slide the auxiliary contact block, remove the auxiliary contact block tab from the groove on the Relay, and remove the auxiliary contact block hook from the Relay.

Be careful not to apply excessive force on the hook.

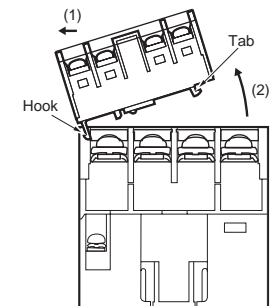

Connecting

- Use round or open-end (Y-type) crimp terminals and connect the terminals with the appropriate tightening torque. Refer to the terminal section space in the following figure for the crimp terminal dimensions.

Relay Contacts (Unit: mm)

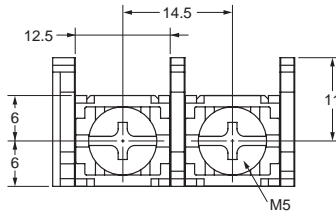

Relay Coil

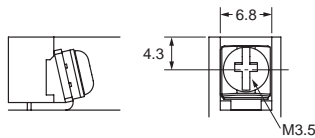

Auxiliary Contact Block

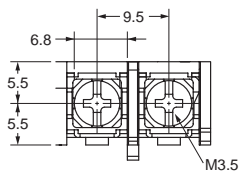

- One crimp terminal can be used for the Relay contact section (M5 screw). Two crimp terminals can be connected for the coil terminal and auxiliary contact block.

Recommended Crimp Terminals and Wire

Location	Crimp terminals	Appropriate wire size
Contact section	5.5-5	2.63 to 6.64 mm ² (AWG12, 10)
	8-5	6.64 to 10.52 mm ² (AWG8)
Coil section	1.25-3.5	0.5 to 1.65 mm ² (AWG20 to 16)

- Use the following tightening torque when tightening screws. Loose screws may result in fire caused by abnormal heat generated when the power is being supplied.
M5 screws: 2.0 to 2.2 N·m
M3.5 screws: 0.8 to 0.9 N·m
- Allow suitable slack on leads when wiring, and do not subject the terminals to excessive force.

Microloads

The G7Z is used for switching power loads, such as current carry for device power supplies and heater loads. Use an auxiliary contact block (G73Z) if microloads are required for signal applications and operation status feedback.

Operating Coil

(Internal Connections of Coils)

DC Coil

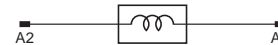

- If a transistor drives the G7Z, check the leakage current and connect a bleeder resistor if necessary.
- The must operate voltage is the minimum value for the Relay armature to operate and the contacts to turn ON. Therefore, fundamentally apply the rated voltage to the coils, taking into consideration the increases in coil resistance caused by voltage fluctuation and coil temperature rise.

Mirror Contact Mechanism

By combining a Relay with an auxiliary contact block, all NC contacts of the auxiliary contact block will satisfy an impulse withstand voltage of more than 2.5 kV or maintain a gap of more than 0.5 mm when the coil is de-energized even if at least one NO contact (main contact) of the Relay is welded (according to EN 60947-4-1).

Description of Mirror Contact Mechanism

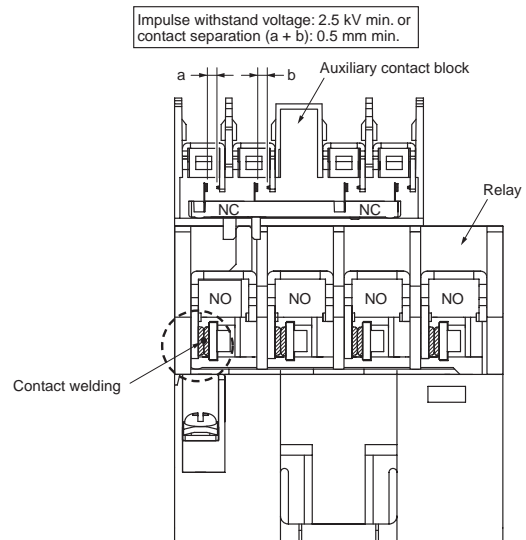

Warranty and Application Considerations

Read and Understand this Catalog

Please read and understand this catalog before purchasing the products. Please consult your OMRON representative if you have any questions or comments.

Warranty and Limitations of Liability

WARRANTY

OMRON's exclusive warranty is that the products are free from defects in materials and workmanship for a period of one year (or other period if specified) from date of sale by OMRON.

OMRON MAKES NO WARRANTY OR REPRESENTATION, EXPRESS OR IMPLIED, REGARDING NON-INFRINGEMENT, MERCHANTABILITY, OR FITNESS FOR PARTICULAR PURPOSE OF THE PRODUCTS. ANY BUYER OR USER ACKNOWLEDGES THAT THE BUYER OR USER ALONE HAS DETERMINED THAT THE PRODUCTS WILL SUITABLY MEET THE REQUIREMENTS OF THEIR INTENDED USE. OMRON DISCLAIMS ALL OTHER WARRANTIES, EXPRESS OR IMPLIED.

LIMITATIONS OF LIABILITY

OMRON SHALL NOT BE RESPONSIBLE FOR SPECIAL, INDIRECT, OR CONSEQUENTIAL DAMAGES, LOSS OF PROFITS, OR COMMERCIAL LOSS IN ANY WAY CONNECTED WITH THE PRODUCTS, WHETHER SUCH CLAIM IS BASED ON CONTRACT, WARRANTY, NEGLIGENCE, OR STRICT LIABILITY.

In no event shall the responsibility of OMRON for any act exceed the individual price of the product on which liability is asserted.

IN NO EVENT SHALL OMRON BE RESPONSIBLE FOR WARRANTY, REPAIR, OR OTHER CLAIMS REGARDING THE PRODUCTS UNLESS OMRON'S ANALYSIS CONFIRMS THAT THE PRODUCTS WERE PROPERLY HANDLED, STORED, INSTALLED, AND MAINTAINED AND NOT SUBJECT TO CONTAMINATION, ABUSE, MISUSE, OR INAPPROPRIATE MODIFICATION OR REPAIR.

Application Considerations

SUITABILITY FOR USE

OMRON shall not be responsible for conformity with any standards, codes, or regulations that apply to the combination of products in the customer's application or use of the products.

Take all necessary steps to determine the suitability of the product for the systems, machines, and equipment with which it will be used.

Know and observe all prohibitions of use applicable to this product.

NEVER USE THE PRODUCTS FOR AN APPLICATION INVOLVING SERIOUS RISK TO LIFE OR PROPERTY WITHOUT ENSURING THAT THE SYSTEM AS A WHOLE HAS BEEN DESIGNED TO ADDRESS THE RISKS, AND THAT THE OMRON PRODUCTS ARE PROPERLY RATED AND INSTALLED FOR THE INTENDED USE WITHIN THE OVERALL EQUIPMENT OR SYSTEM.

Disclaimers

PERFORMANCE DATA

Performance data given in this catalog is provided as a guide for the user in determining suitability and does not constitute a warranty. It may represent the result of OMRON's test conditions, and the users must correlate it to actual application requirements. Actual performance is subject to the OMRON *Warranty and Limitations of Liability*.

CHANGE IN SPECIFICATIONS

Product specifications and accessories may be changed at any time based on improvements and other reasons. Consult with your OMRON representative at any time to confirm actual specifications of purchased product.

DIMENSIONS AND WEIGHTS

Dimensions and weights are nominal and are not to be used for manufacturing purposes, even when tolerances are shown.

ALL DIMENSIONS SHOWN ARE IN MILLIMETERS.

To convert millimeters into inches, multiply by 0.03937. To convert grams into ounces, multiply by 0.03527.

Cat. No. J160-E1-01 **In the interest of product improvement, specifications are subject to change without notice.**

OMRON Corporation
Industrial Automation Company

Control Devices Division H.Q.
Industrial Components Department
Shiokoji Horikawa, Shimogyo-ku,
Kyoto, 600-8530 Japan
Tel: (81)75-344-7119/Fax: (81)75-344-7149

Regional Headquarters
OMRON EUROPE B.V.
Wegalaan 67-69, NL-2132 JD Hoofddorp
The Netherlands
Tel: (31)2356-81-300/Fax: (31)2356-81-388

OMRON ELECTRONICS LLC
1 East Commerce Drive, Schaumburg,
IL 60173 U.S.A.
Tel: (1)847-843-7900/Fax: (1)847-843-8568

OMRON ASIA PACIFIC PTE. LTD.
83 Clemenceau Avenue,
#11-01, UE Square,
239920 Singapore
Tel: (65)6835-3011/Fax: (65)6835-2711

OMRON (CHINA) CO., LTD.
Room 2211, Bank of China Tower,
200 Yin Cheng Road (M),
Shanghai, 200120 China
Tel: (86)21-5037-2222/Fax: (86)21-5037-2200